

?

D

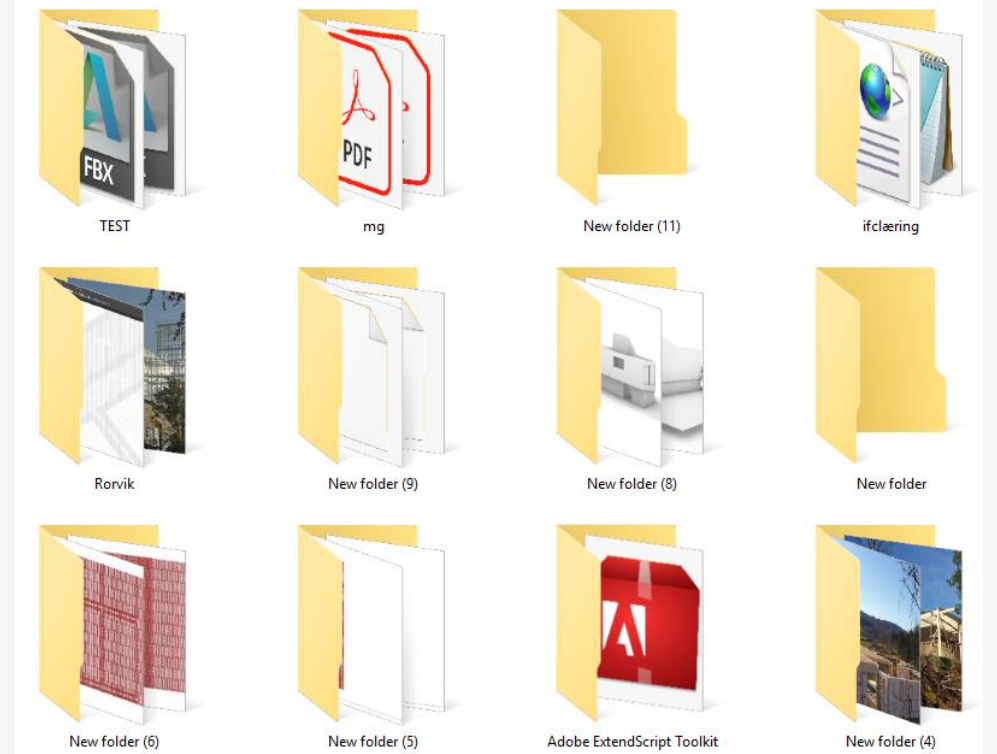

Fysisk Folder

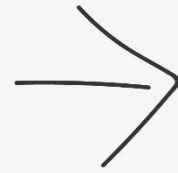

Digital Folder

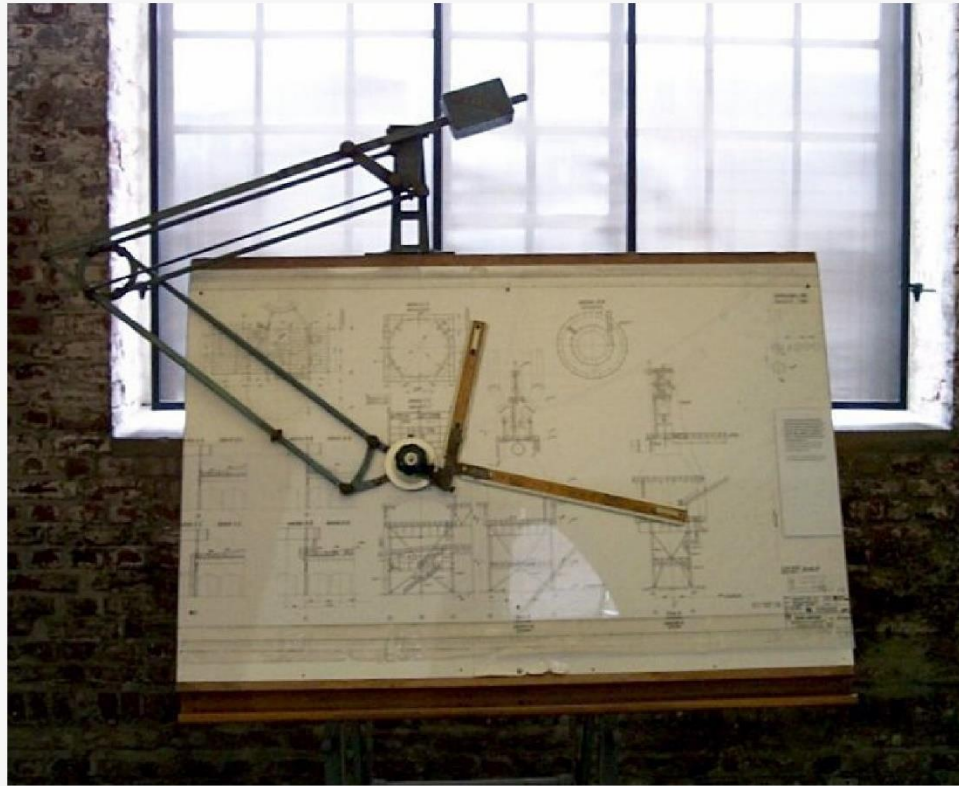

Fysisk Tegnebrett

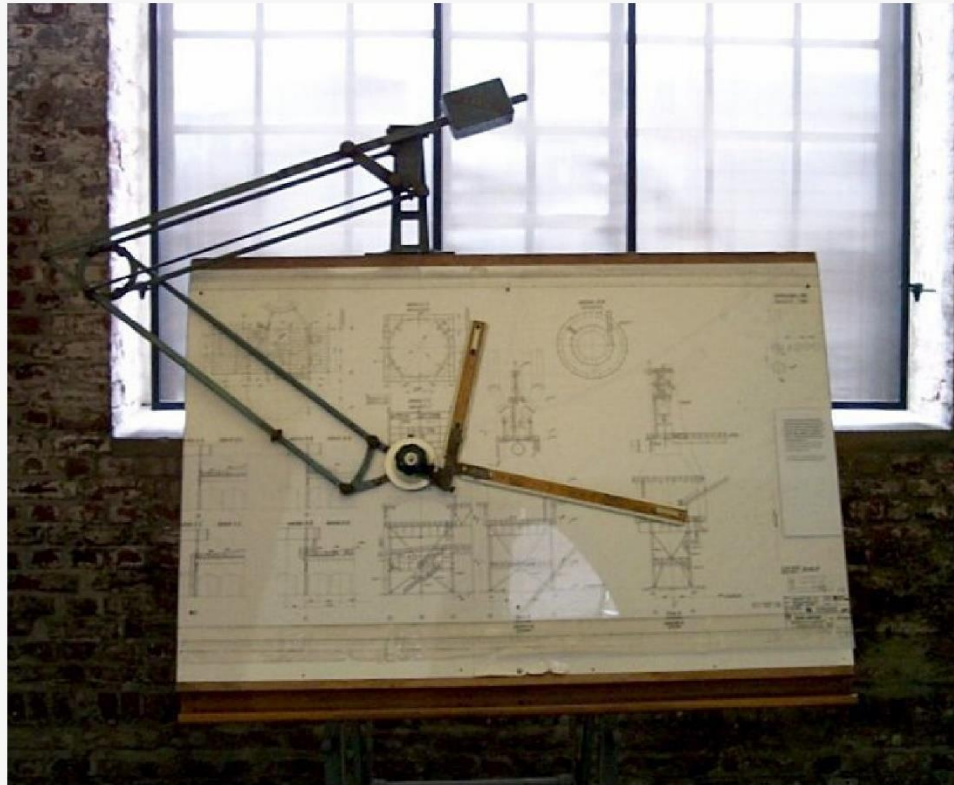

Fysisk Tegnebrett

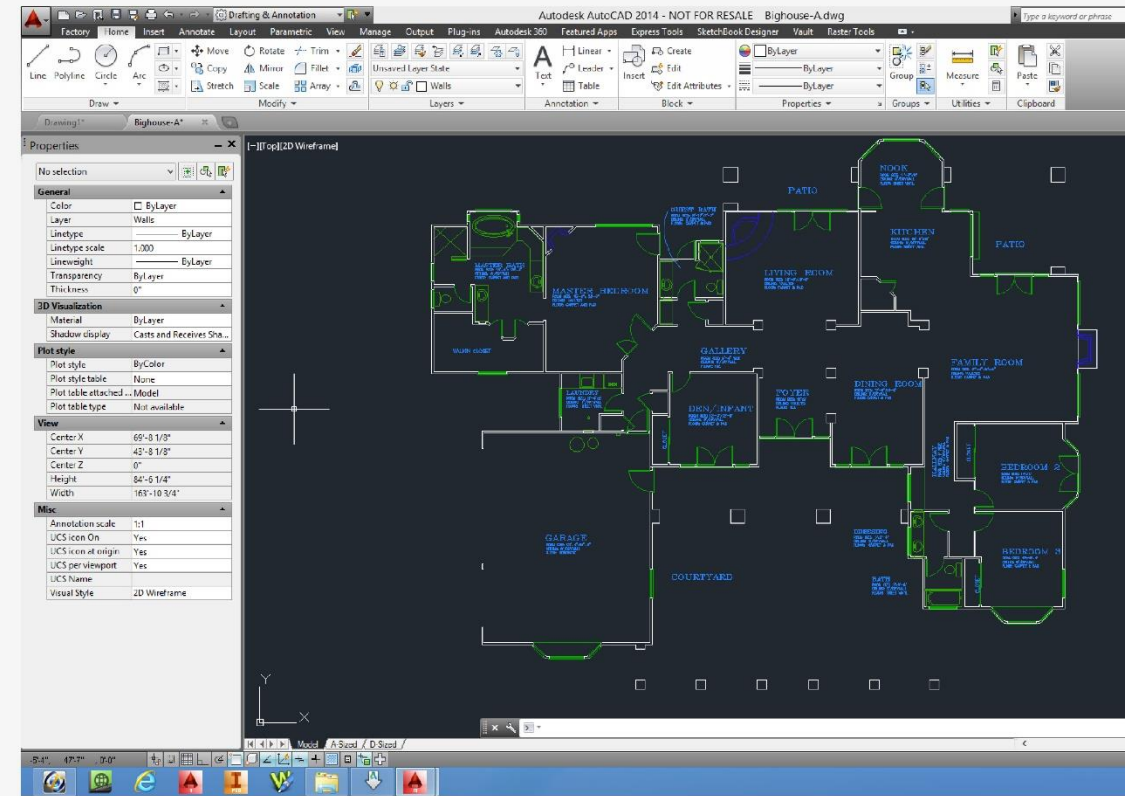
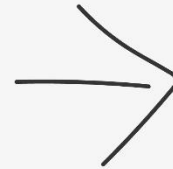

Digitalt Tegnebrett



Personlegheits-
forstyrningar
i
Byggebransja

John Haddal Mork
NTNU / RALLAR

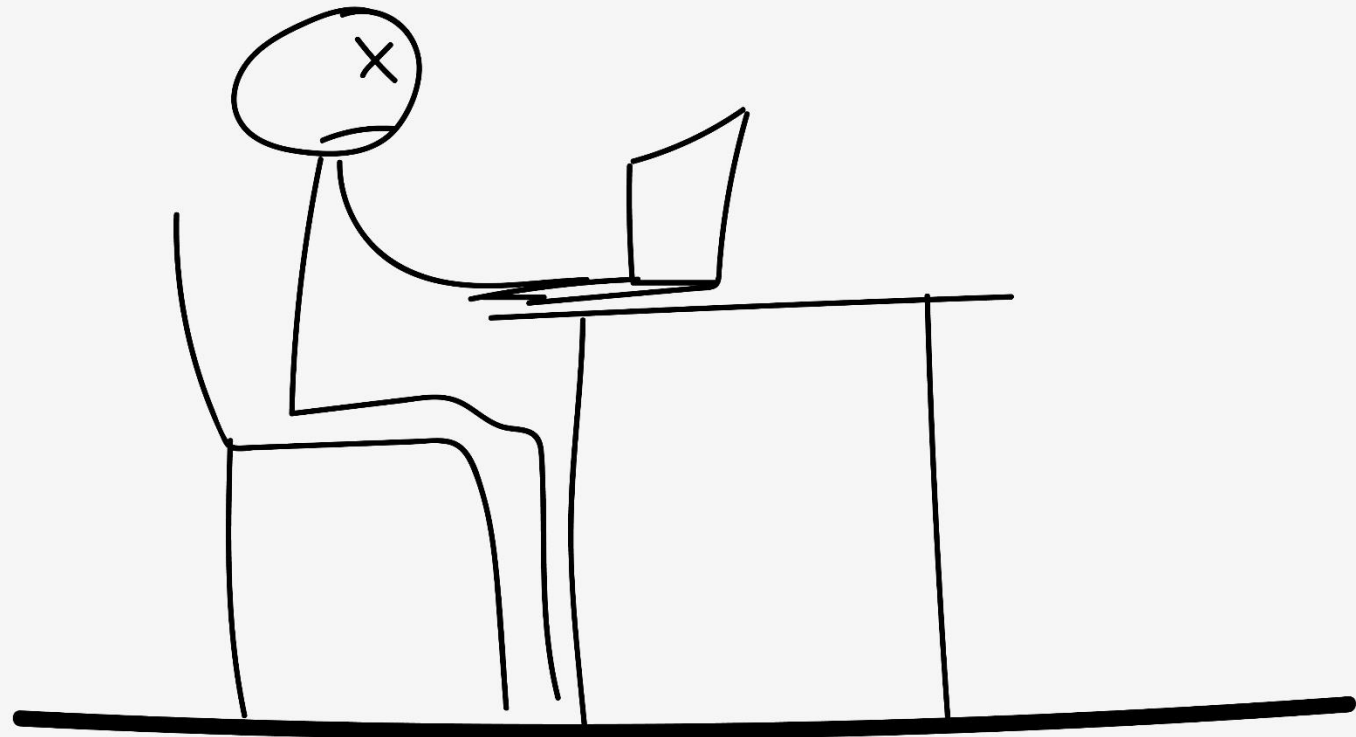

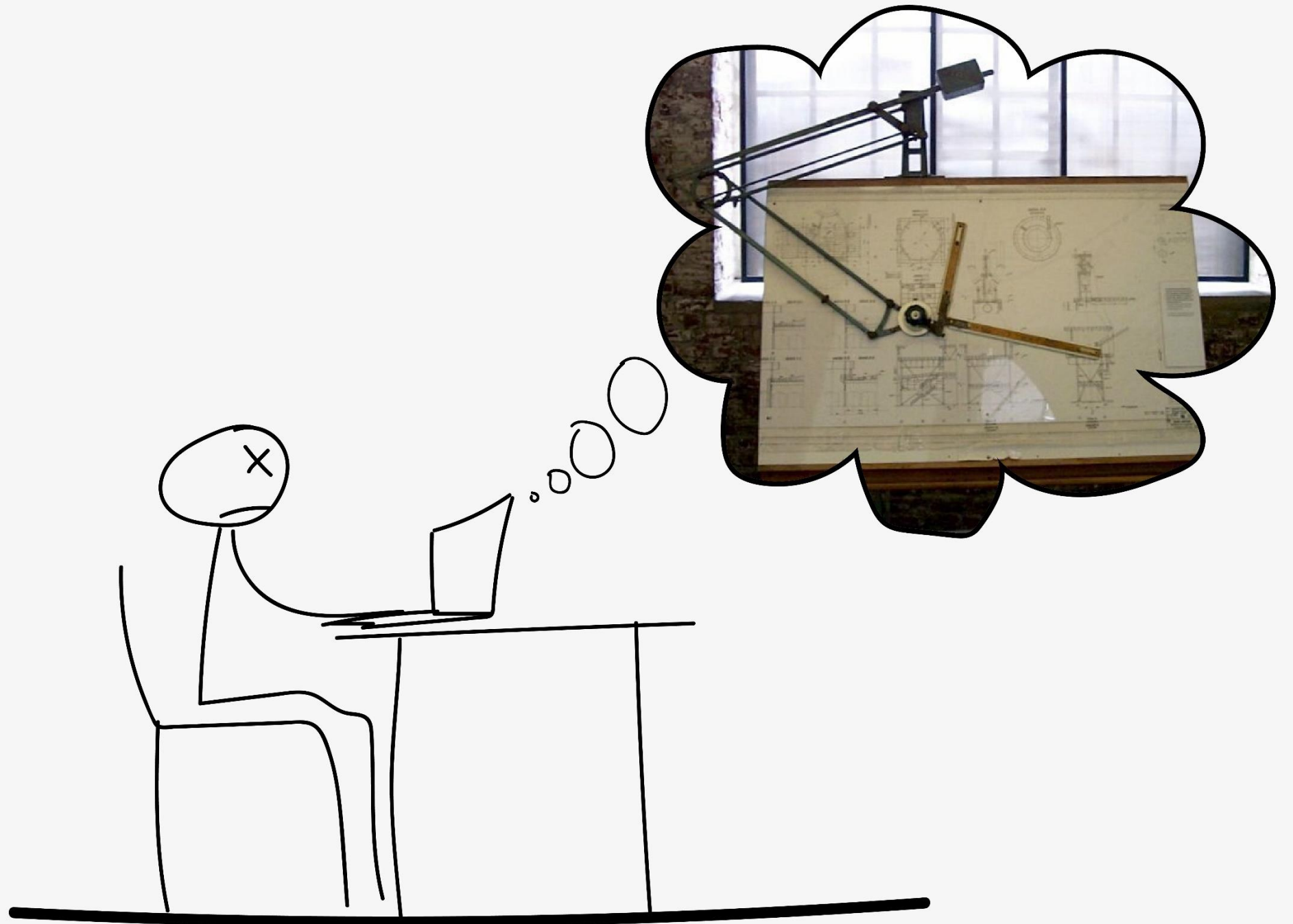

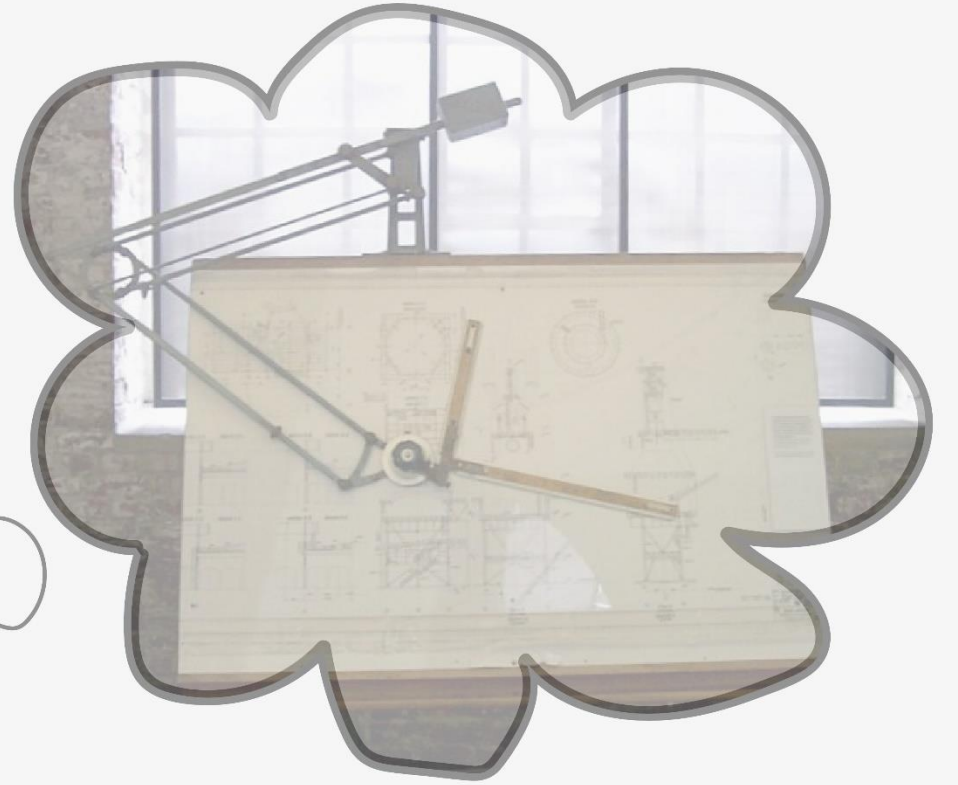
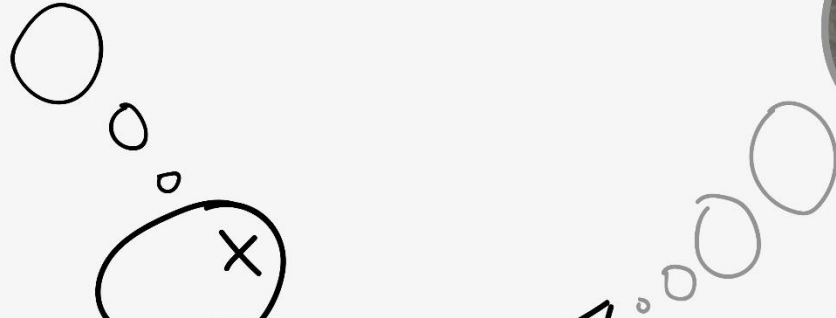
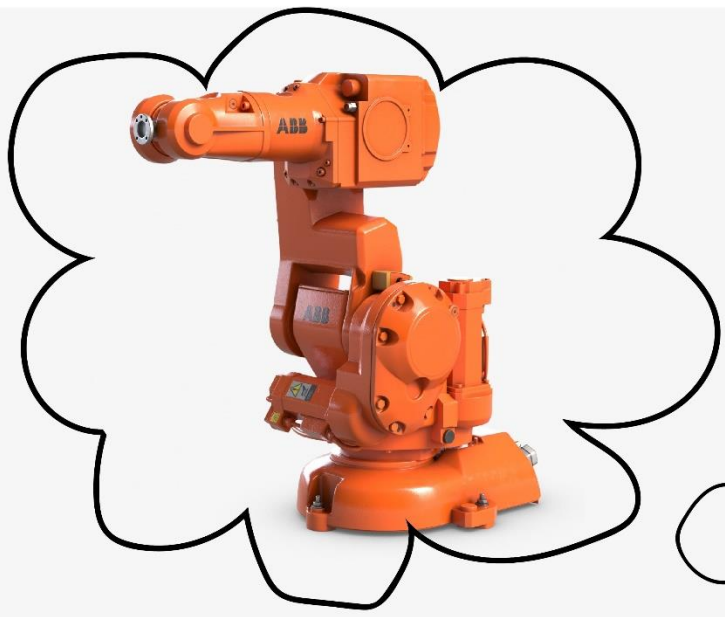



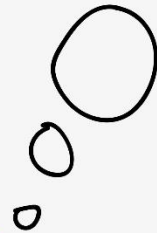

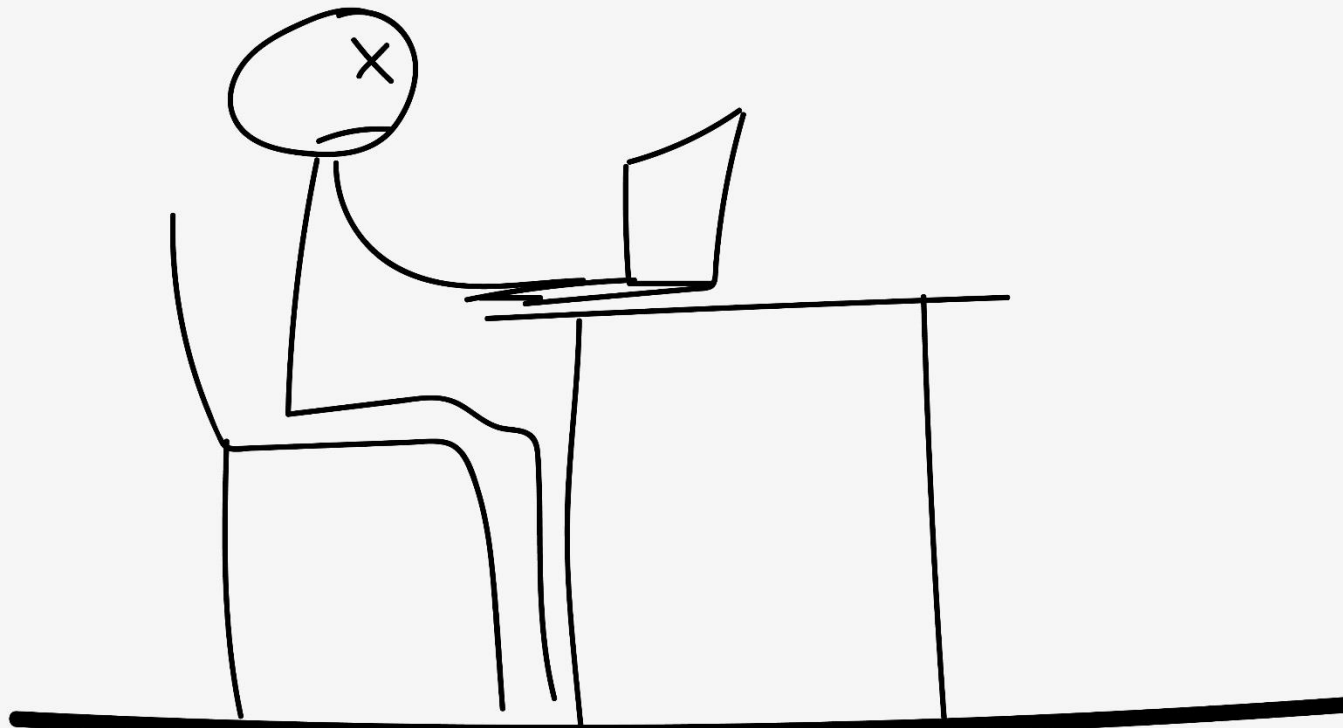

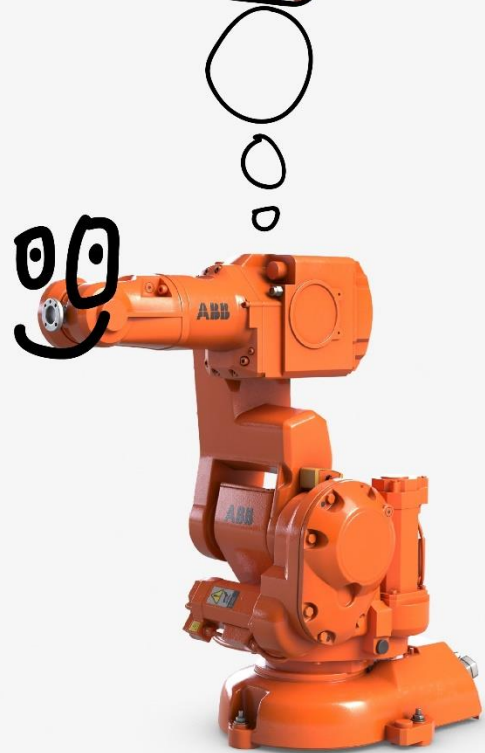
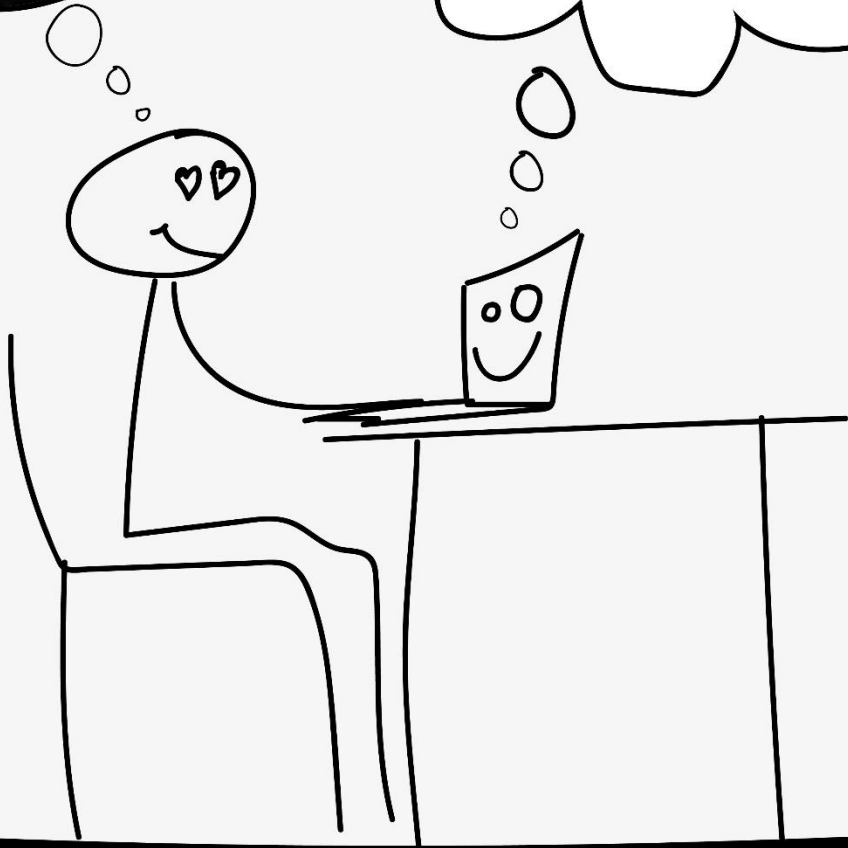

Ein parametrisk revolusjon

John Haddal Mork

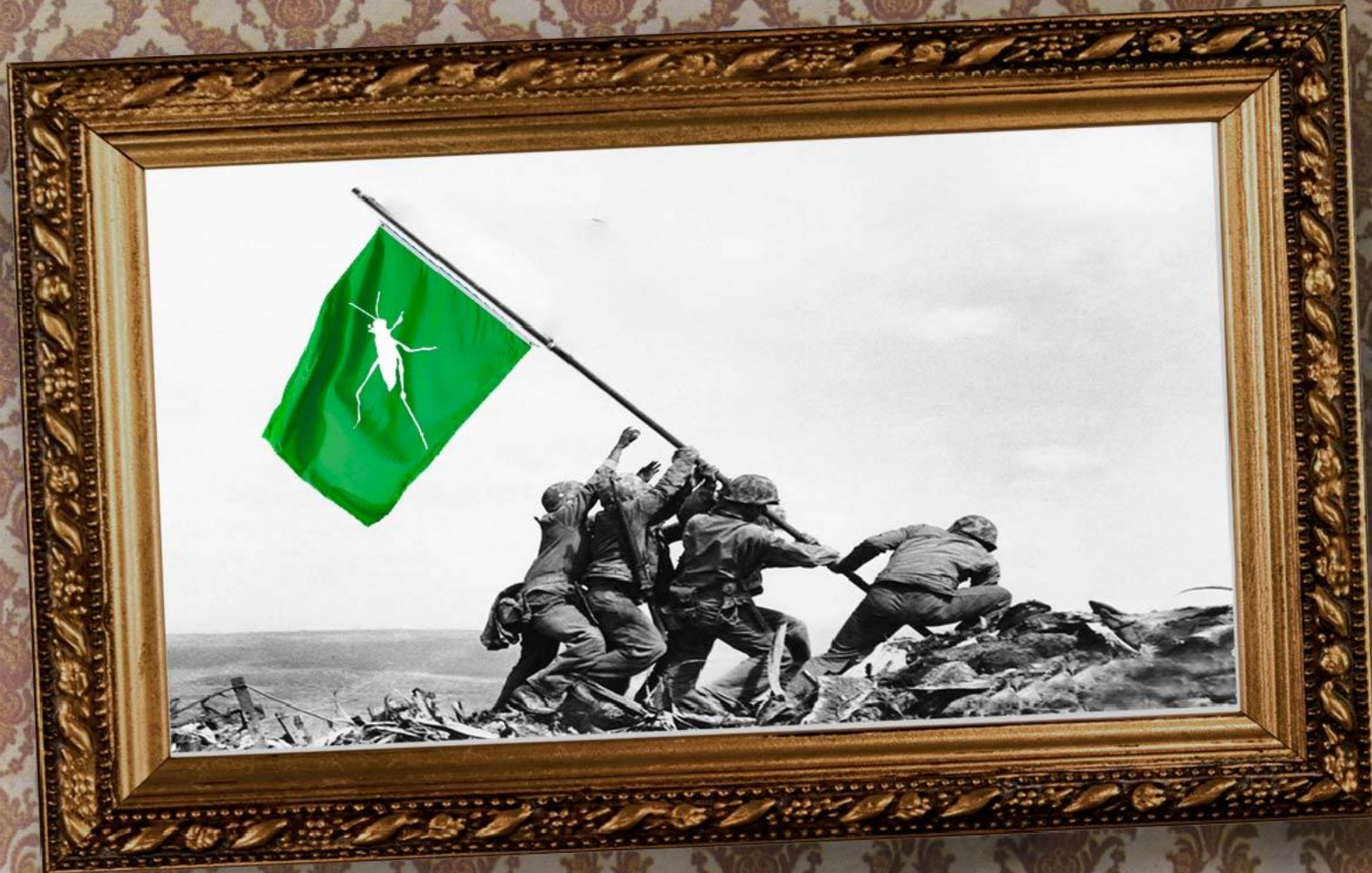

KVA ER PARAMETRISK MODELLERING?

File Home Insert Page Layout Formulas Data Review View Results Connect Acrobat Team Tell me what you want to do...

Cut Copy Paste Format Painter Clipboard

Font: 28, Bold, Italic, Underline, Paragraph, Font Color

Alignment: Wrap Text, Merge & Center, Text Alignment

Number: General, Percentage, Decimals

Styles: Normal, Bad, Good, Check Cell, Explanatory..., Input

	A	B	C	D	E	F	G	H	I	J	K	L
1	Vare	Kg pris	Antal kg	Pris								
2	Epler	12	7	=C2*B2								
3												
4												
5												
6												
7												
8												
9												
10												
11												
12												
13												
14												
15												
16												
17												
18												



Window Default Settings

Embedded Library

- Linked Libraries
 - Bibliotek 21
 - 1.2 Dører
 - 1.3 Vinduer
 - Butikkfasader
 - Enkle vinduer
 - Karmappvinduer
 - Skyvevinduer
 - Spesialvinduer
 - Veggåpninger vindu
 - Vinduer heve-senke
 - 1.4 Bygningskonstruksjoner
 - BIMcloud / BIM Server Libraries
 - Built-in Libraries

Vindu

PREVIEW AND POSITIONING

900

1500

Anchors:

Sill to Wall base

900

Reveal to Wall Core

0

Flip

INNSTILLINGER VINDU

Størrelsesforhold...

Sett som størrelsesforhold

	Bredde	Høyde
<input type="radio"/> 1. Veggåpningsmål	920	1520
<input type="radio"/> 2. Smygåpningsmål	920	1520
<input checked="" type="radio"/> 3. Karmyttermål	900	1500

Overfør gjeldende nominell størrelse til valgte

10

10

10

10

Vindu

Vindu med sidefelt

Vindu multi-rams horisontalt

Vindu to-fags

Empty Opening

FLOOR PLAN AND SECTION

DIMENSION MARKER

INNSTILLINGER VINDUSSTEMPEL

CLASSIFICATION AND PROPERTIES

Cancel OK

KVA ER PARAMETRISK MODELLERING?

Oppbygging av eit logisk system basert på parameter og geometriske samanhengar



Vanleg måte:

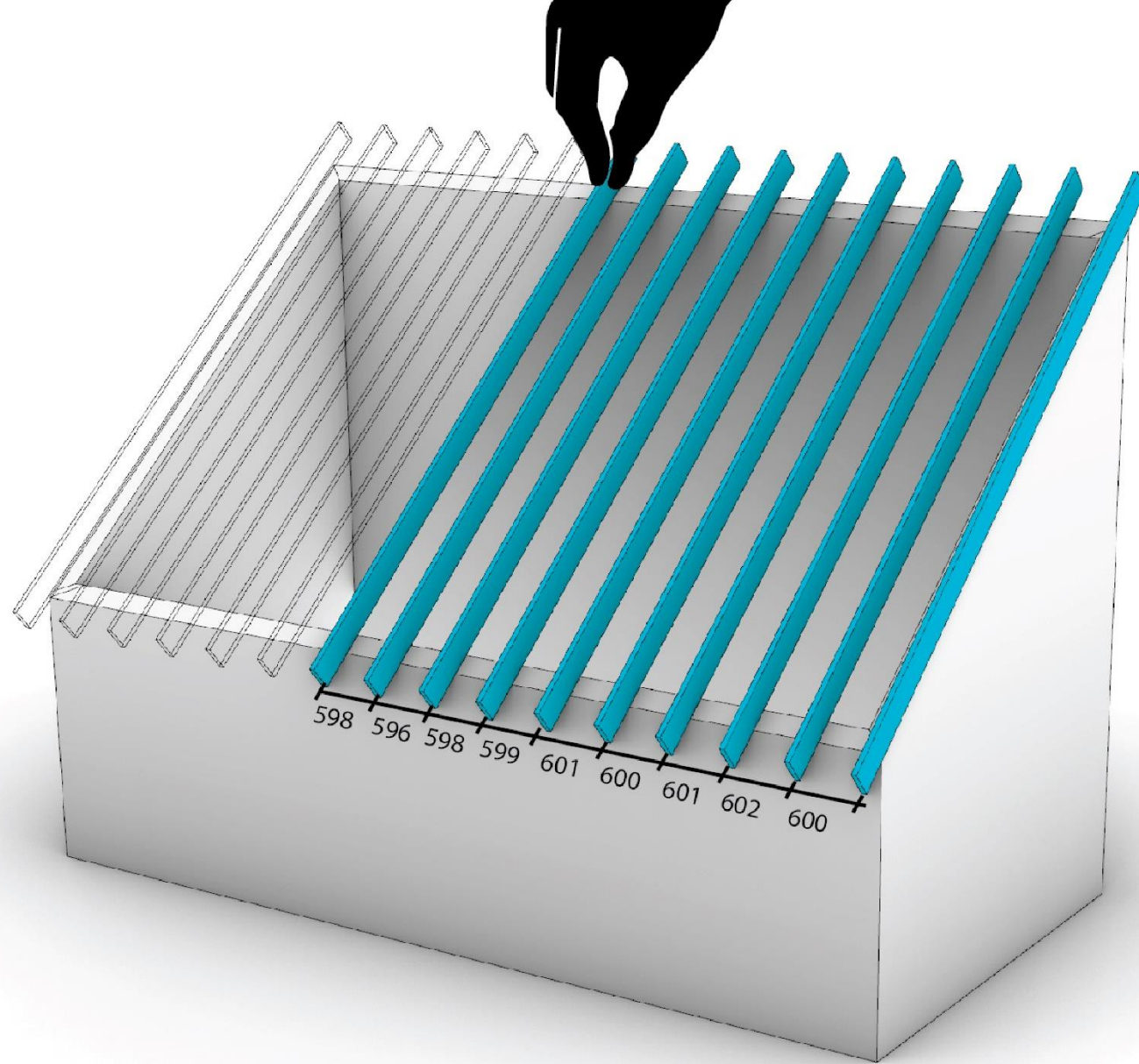

Parametrisk måte

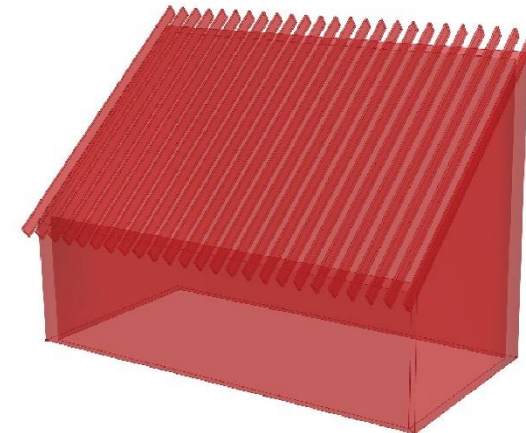
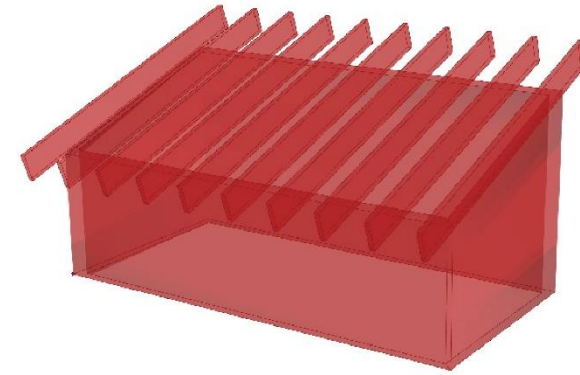
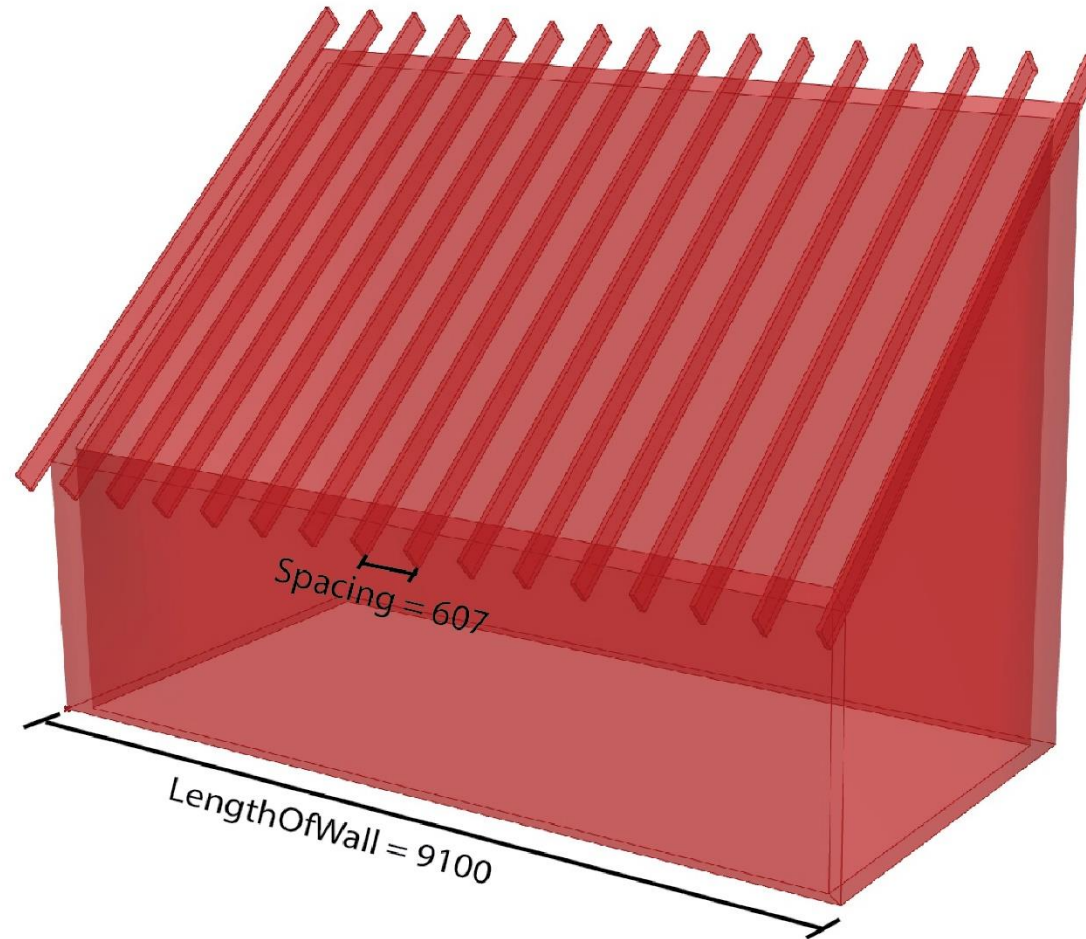

Wanted GridSpacing: 600mm

↳ SpacingAmount = $\text{Floor}(\text{LengthOfWall}/\text{GridSpacing}) = 15$

↳ Amount of beams = $\text{SpacingAmount} + 1 = 16$

↳ Spacing = $\text{LengthOfWall}/\text{SpacingAmount} = 607$

Grasshopper - background*

File Edit View Display Solution Help AutoGraph background

P M S V C S M X T D V H L A S W H M G K K L M F R M T M R H

Geometry Primitive Input Util OpenNest

138%

HouseLength 8956

HouseDepth 4385

RoofHeight 1519

Wanted BeamDistance 1000

Resulting BeamDistance 995.111111

BeamExtend 1000

Width 100

Height 576

DivBackgroundInLayers.3dm (688 KB) - Rhino 6 Commercial - [Perspective]

File Edit View Curve Surface Solid Mesh Dimension Transform Tools Analyze Render Panels Help

Image successfully saved as C:\Users\Lokaladm\Google Drive\PHD\ThesisFinalFinalFinal\Illustrations\Background\Temp\houseParametric2.jpg
Command: ViewCaptureToFile

Standard CPlanes Set View Display Select Viewport Layout Visibility Transform Curve Tools Surface Tools Solid Tools Mesh Tools Render Tools Drafting

Perspective

Perspective Top Front Right

End Near Point Mid Cen Int Perp Tan Quad Knot Vertex Project Disable

CPlane x-964.86 y-2108.50 z 0.00 Millimeters Default Grid Snap Ortho Planar Osnap SmartTrack Gumball Record History Filter A.

Masseprodusert skreddarsaum i trearkitektur

Frå å designe konstruksjon**en**
til å designe konstruksjon**systemet**

Frå Konstruksjon**en**

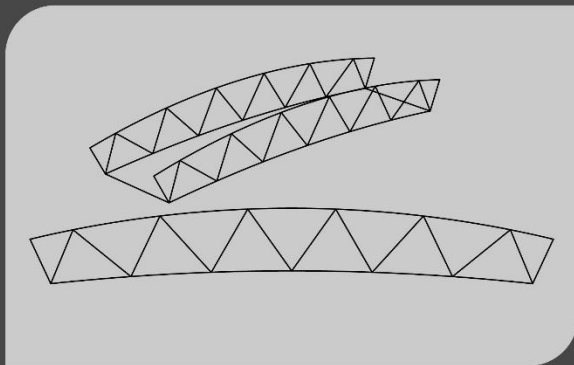

Konstruksjon**1**

Frå Konstruksjon**en**

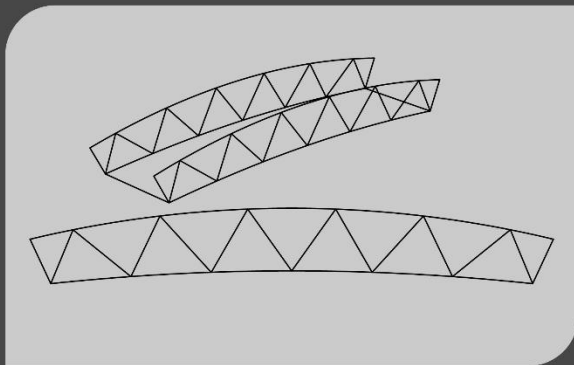

Konstruksjon**1**

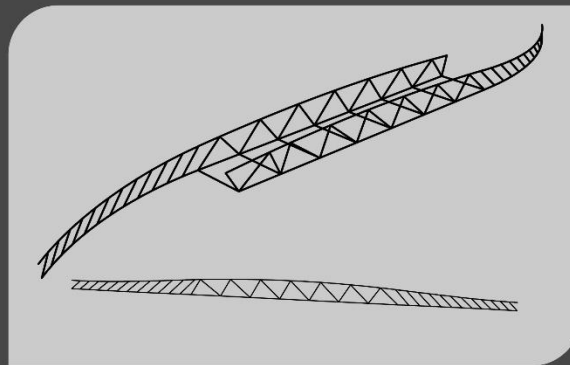

Konstruksjon**2**

Frå Konstruksjon**en**

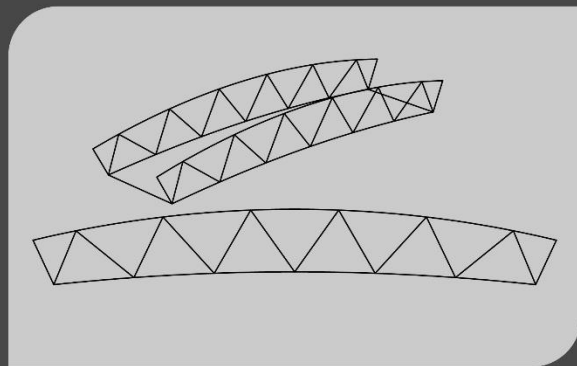

Konstruksjon**1**

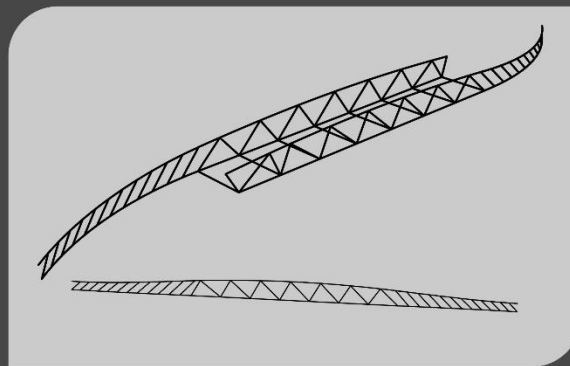

Konstruksjon**2**

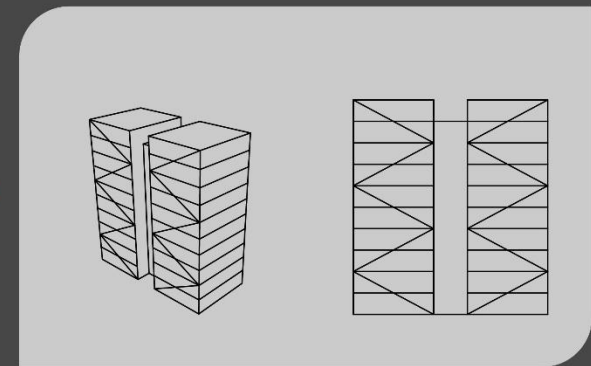

Konstruksjon**3**

Til konstruksjon **systemet**



Konstruksjon-
System

Til konstruksjon **systemet**



Konstruksjon-
System

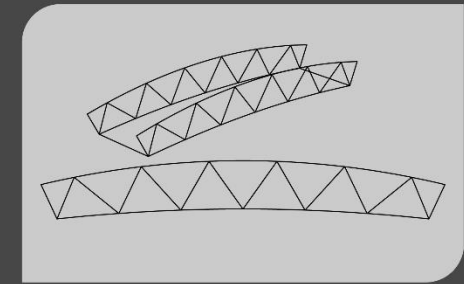

Konstruksjon**1**

Til konstruksjon **systemet**



Konstruksjon-
System

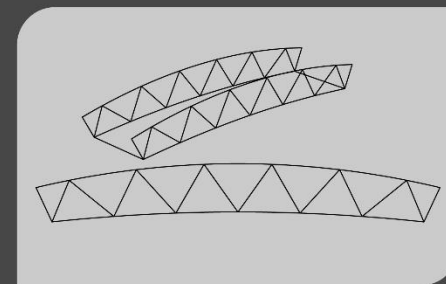
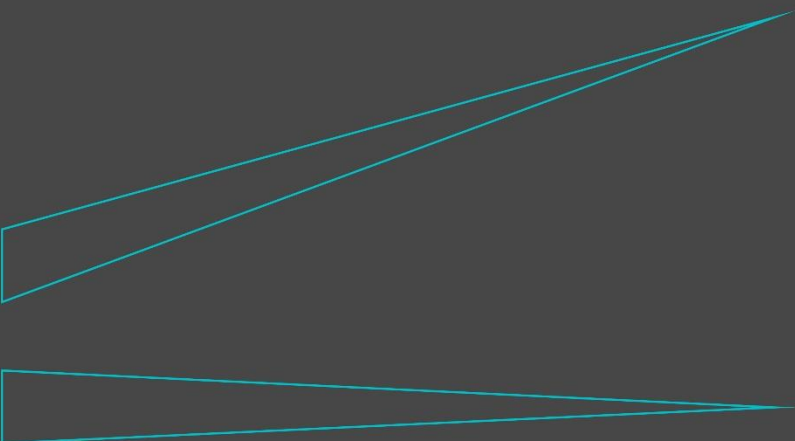

Konstruksjon **1**

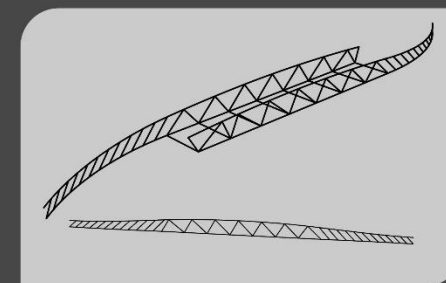

Konstruksjon **2**

Til konstruksjon **systemet**



Konstruksjon-
System

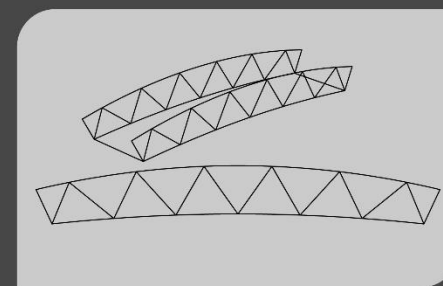

Konstruksjon **1**

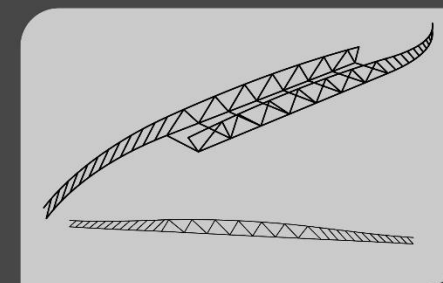

Konstruksjon **2**

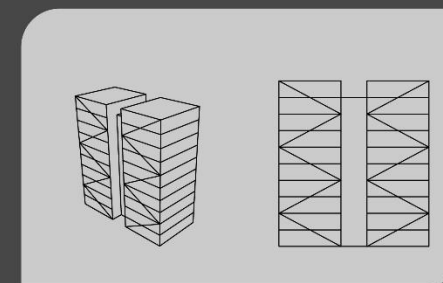

Konstruksjon **3**



Konstruksjon **System**



SenterLinjeGeometri



Produkt

Konstruksjon **System**



SenterLinjeGeometri



Produkt

Konstruksjon **System**



SenterLinjeGeometri

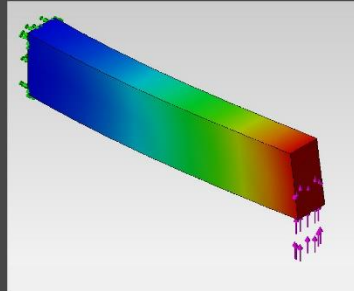

KonstruksjonsAnalyse



Produkt

Konstruksjon **System**



SenterLinjeGeometri

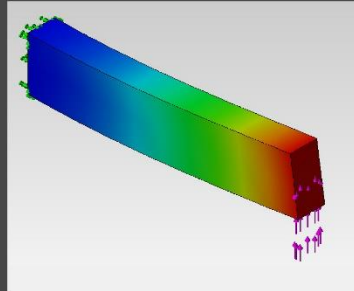

KonstruksjonsAnalyse

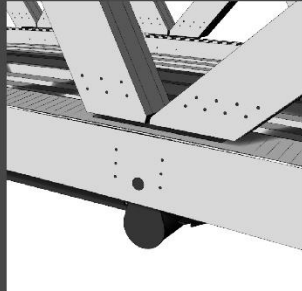

Detaljering



Produkt

Konstruksjon **System**



SenterLinjeGeometri

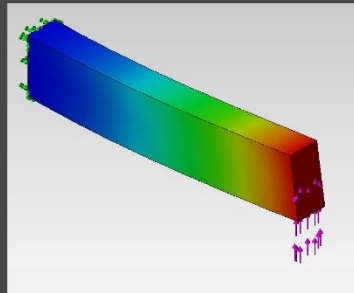

KonstruksjonsAnalyse

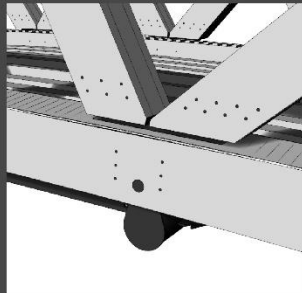

Detaljering

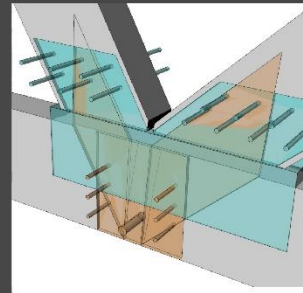

CAM-instruksjoner



Produkt

Konstruksjon**System**



SenterLinjeGeometri

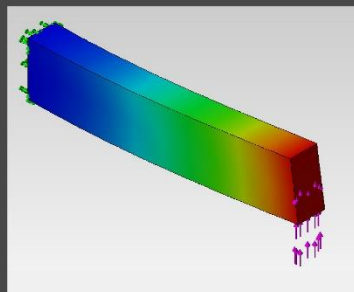

KonstruksjonsAnalyse

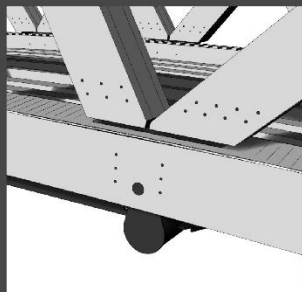

Detaljering

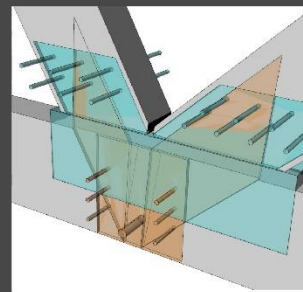

CAM-instruksjoner



Digital Fabrikasjon



Produkt



Konstruksjon**System**

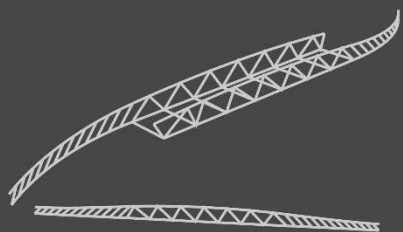

SenterLinjeGeometri



Konstruksjon **System**

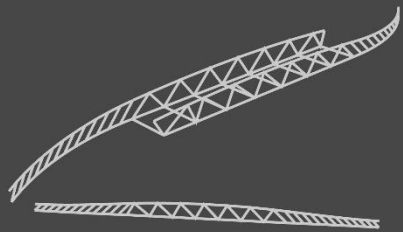

SenterLinjeGeometri

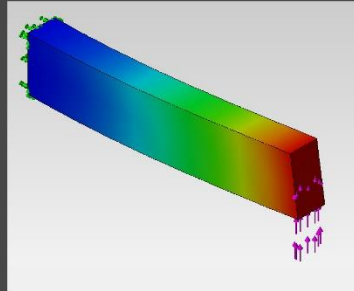

KonstruksjonsAnalyse



Konstruksjon **System**

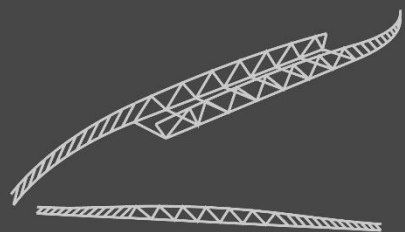

SenterLinjeGeometri

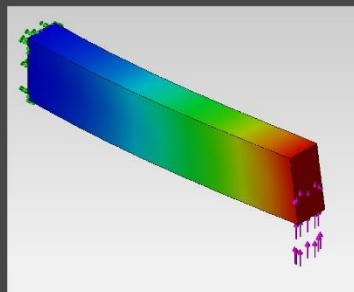

KonstruksjonsAnalyse

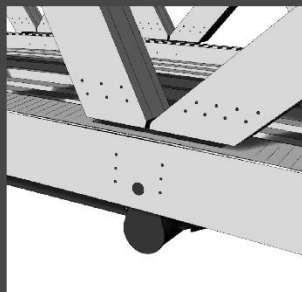

Detaljering



Konstruksjon **System**

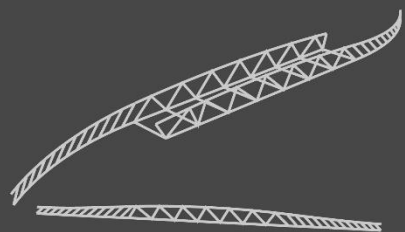

SenterLinjeGeometri

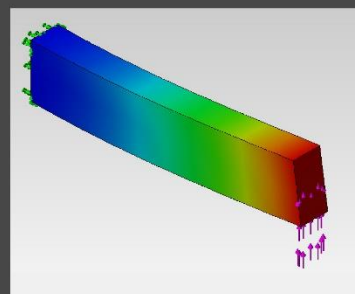

KonstruksjonsAnalyse

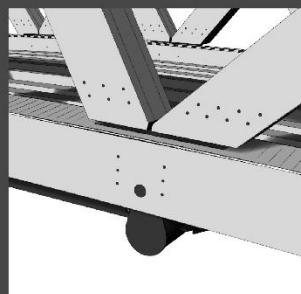

Detaljering

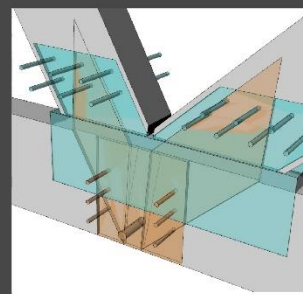

CAM-instruksjoner



Konstruksjon **System**

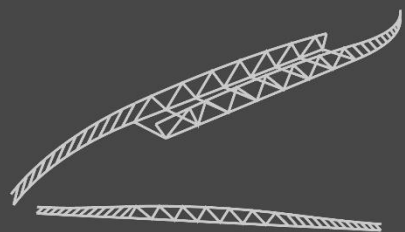

SenterLinjeGeometri

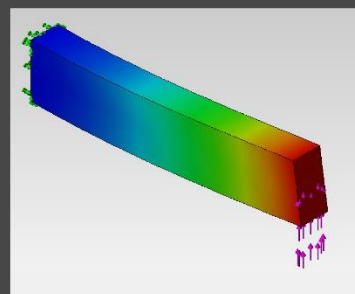

KonstruksjonsAnalyse

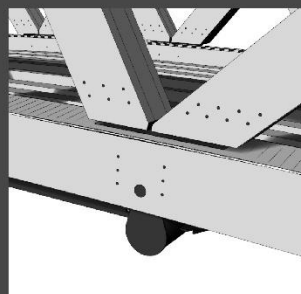

Detaljering

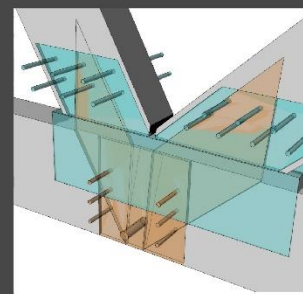

CAM-instruksjoner



Digital Fabrikasjon



Konstruksjon**System**

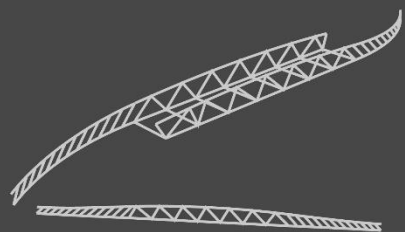

SenterLinjeGeometri

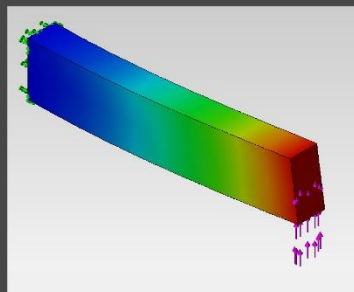

KonstruksjonsAnalyse

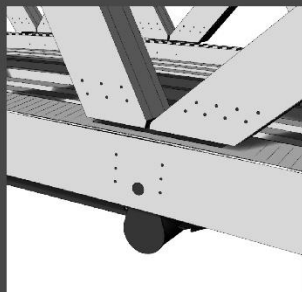

Detaljering

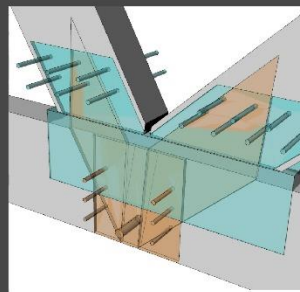

CAM-instruksjoner



Digital Fabrikasjon



Produkt

Konstruksjon**System**

Identifisering av detaljar

Overgang frå Design til Produksjon

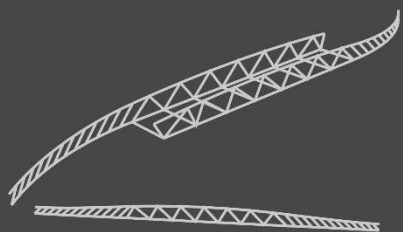

SenterLinjeGeometri

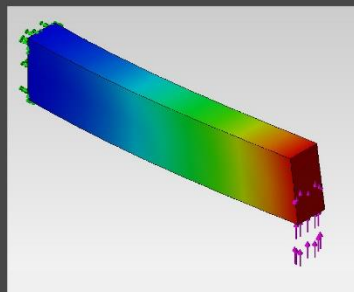

KonstruksjonsAnalyse

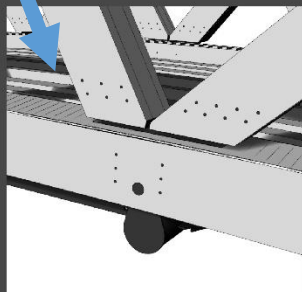

Detaljering

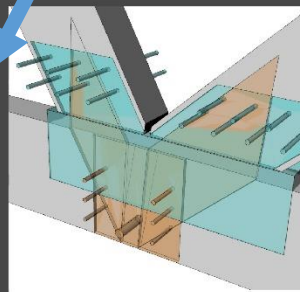

CAM-instruksjoner



Digital Fabrikasjon



Produkt



Konstruksjon**System**

REINDEER (by John Haddal Mork)



Reindeer is an open-source, work in progress plugin for Grasshopper. It aims to simplify the process of designing, detailing and fabricating timber structures parametrically. The plugin includes tools for defining a timber element, search for details, analyze a structure according to Eurocode 5 and detail a structure using timber processing.

Please download after carefully reading and accepting the [Terms of Use and Disclaimer](#).
Password to unzip the software is found at the bottom of the [License page](#).

The reindeer is an animal that lives around the polar circle. Through harsh and ever-changing climates and landscape topologies, he searches for food by sniffing out lichen beneath the snow. Similarly, the reindeer toolkit searches for parametric details using geometric properties. Search, don't sort: No matter if the topology and typology changes, the toolkit will still find valid details.

Summary of features:

[+ more](#)

Category: Architecture, Import & Export, Manufacturing & Fabrication, Structural Engineering

License: Free

Download



Your vote: 5
5.0 (4 votes)

Downloads:

199

[Website](#)

[Support Email](#)

[License](#)

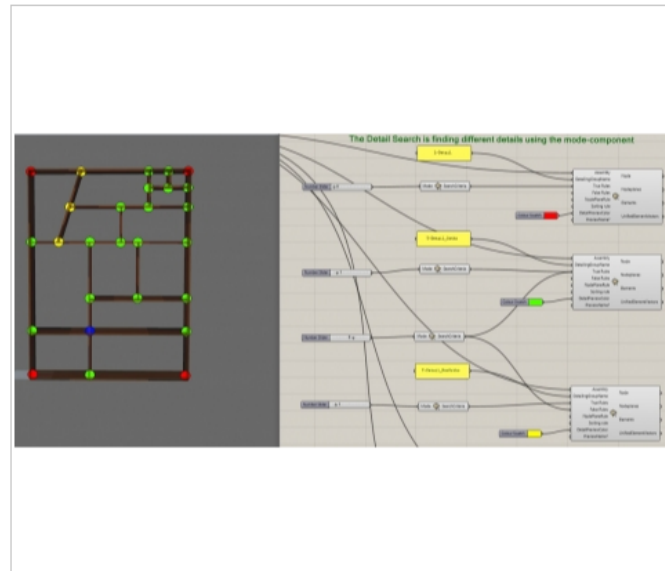

Automatisk detaljidentifisering

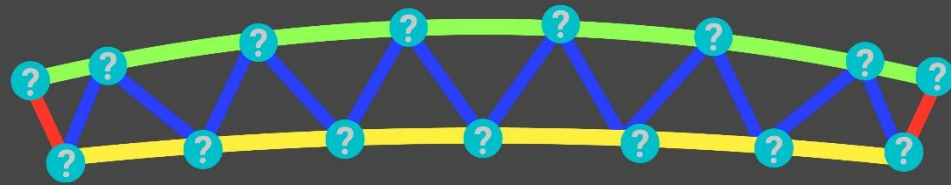

SenterLinjeGeometri



Produkt



David

Charles

Eric

Joe

Alex

Philip

Max

Anne

Maria

Robert

Bernard

Richard

Anita

Tom

Bill

Frans

George

Susan

Peter

Paul

Sam

Alfred

Herman

Claire



David

Charles

Eric

Joe

Alex

Philip

Max

Anne

Maria

Robert

Bernard

Richard

Anita

Tom

Bill

Frans

George

Susan

Peter

Paul

Sam

Alfred

Herman

Claire

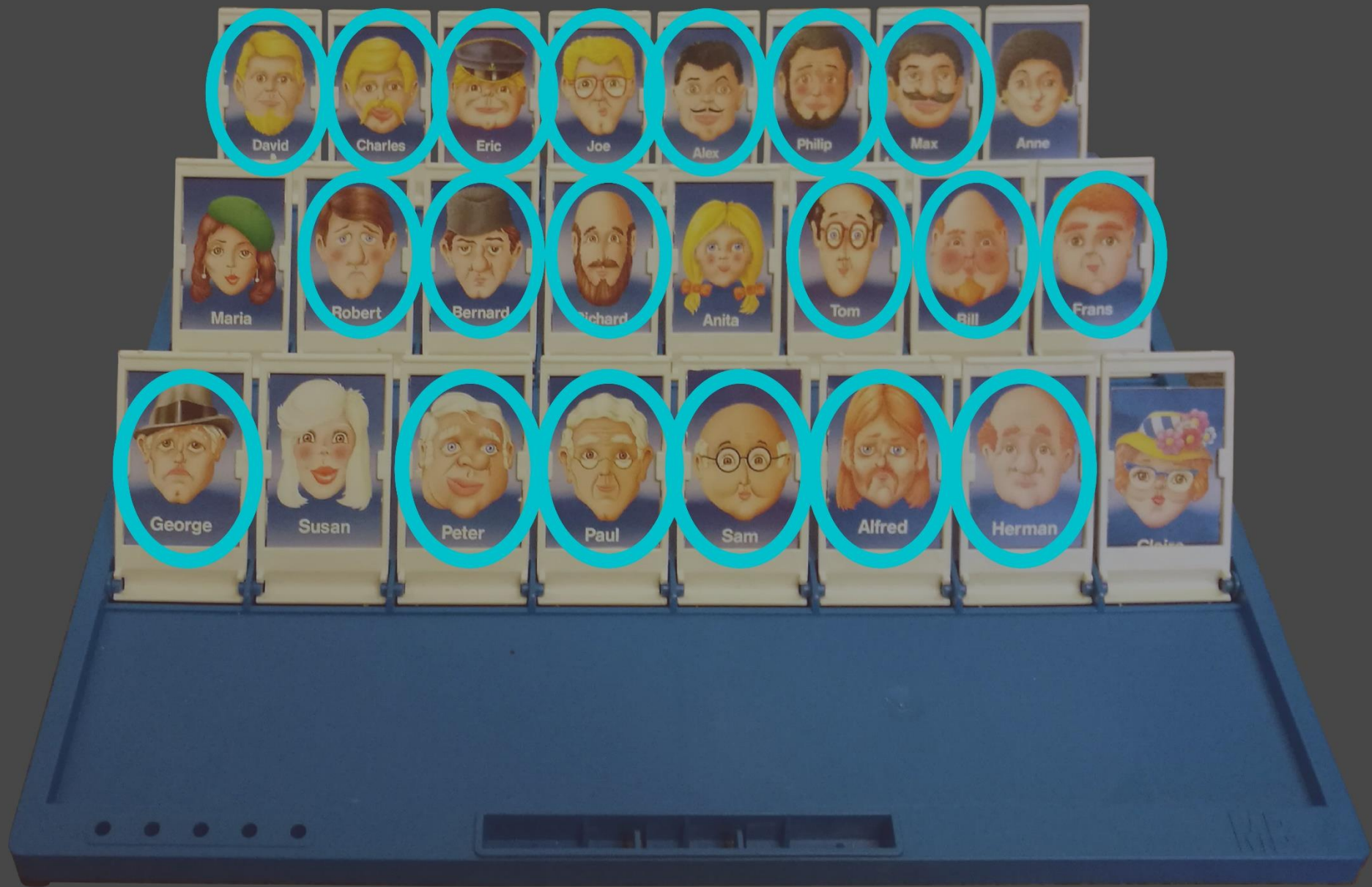



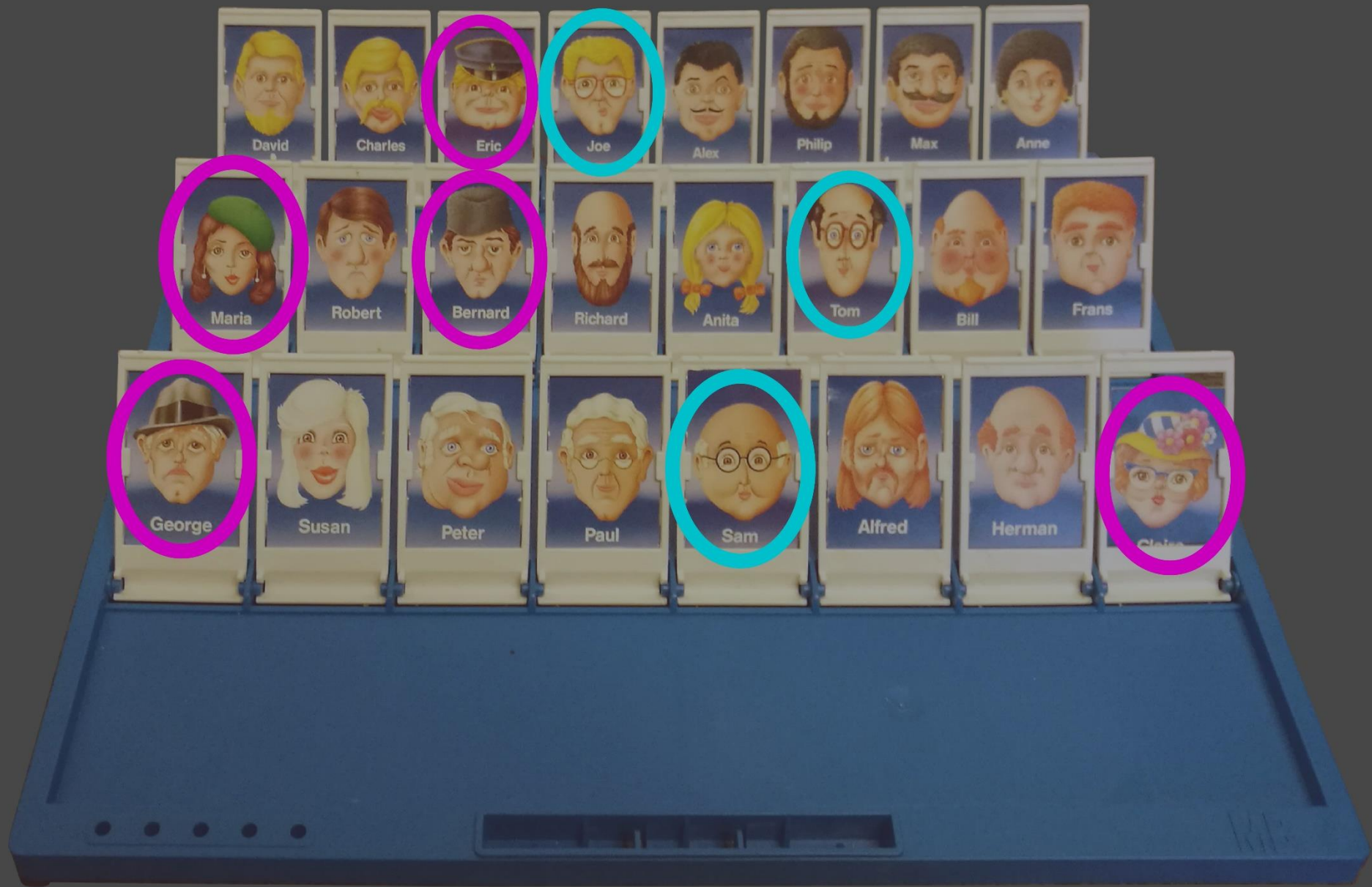

Automatisk detaljidentifisering

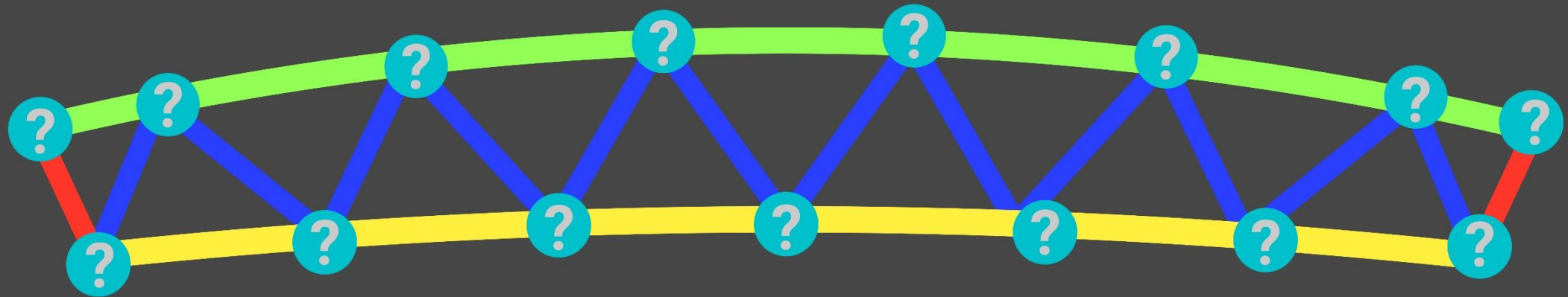

Automatisk detaljidentifisering

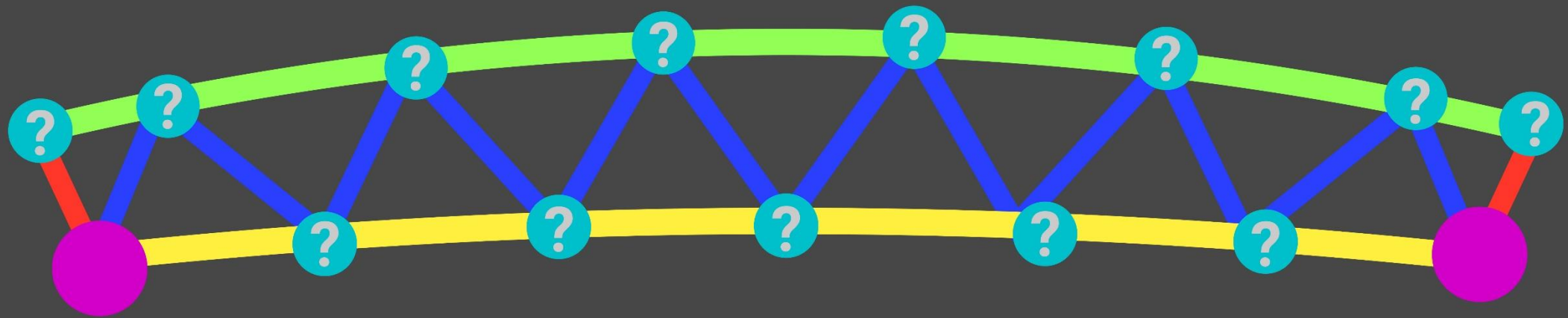

Fundament: **1 Undergurt**, **1 Stav** og **1 Nullstav**



Automatisk detaljidentifisering

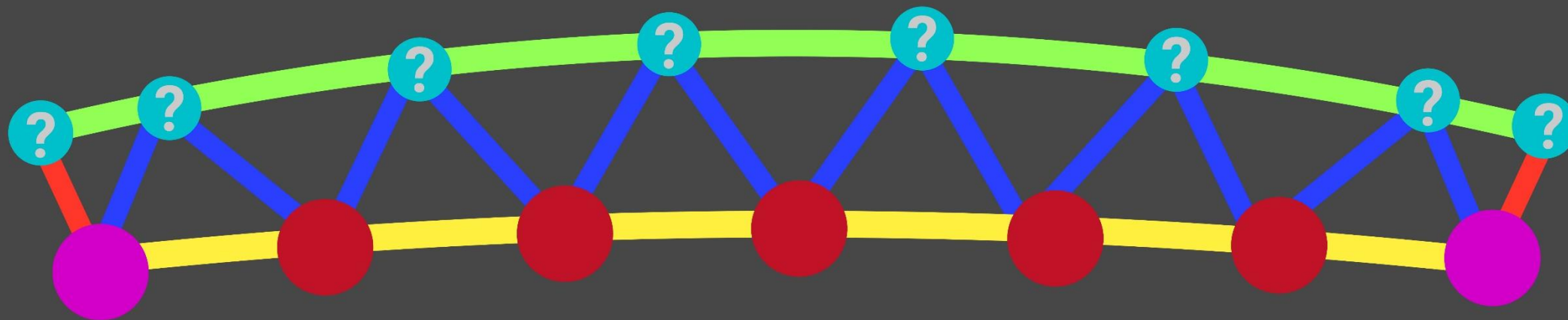

UndergurtDetalj: **1 Undergurt**, og **2 Stavar** ●

Automatisk detaljidentifisering

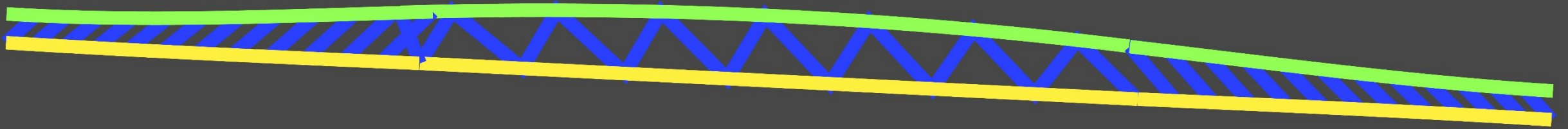

Automatisk detaljidentifisering

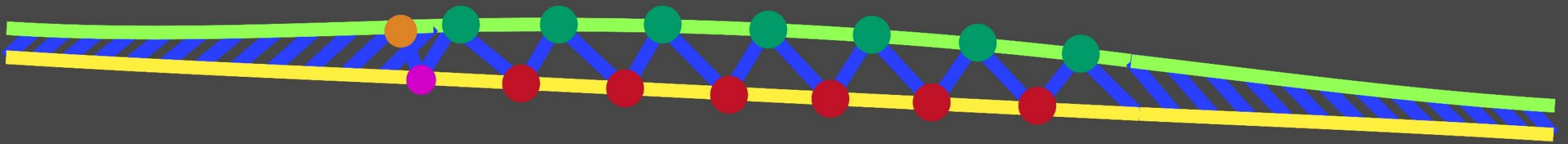

Overgang fra **Design**

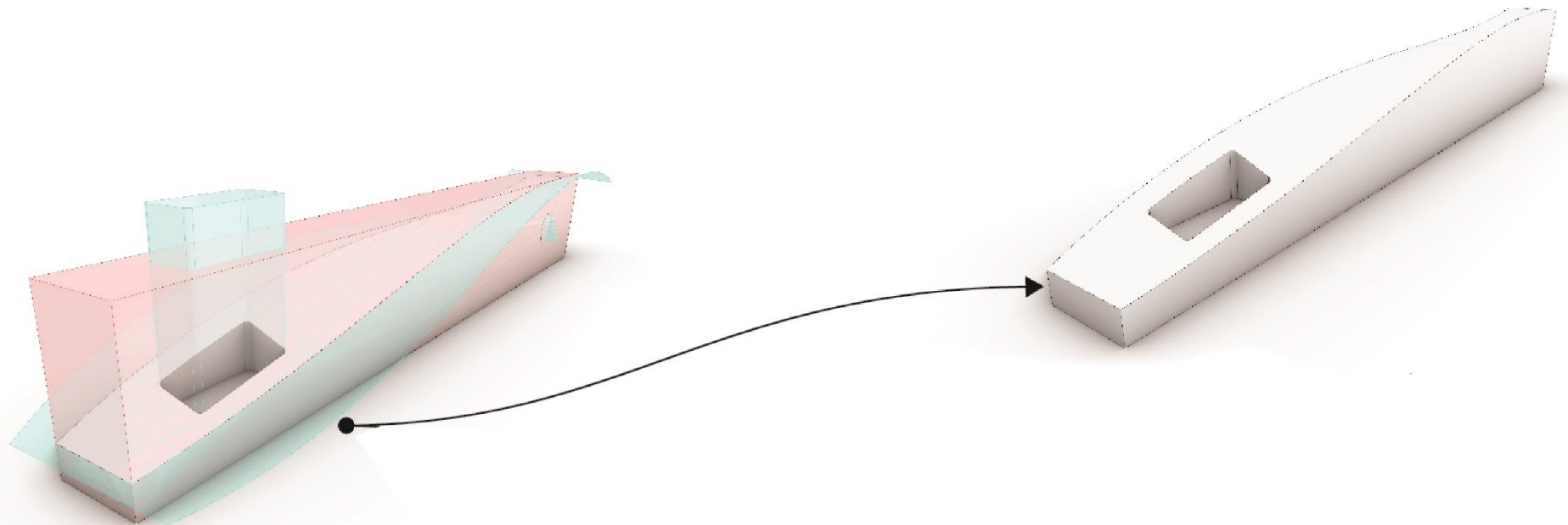

Subtractive Operations

Overgang frå Design til **Produksjon**

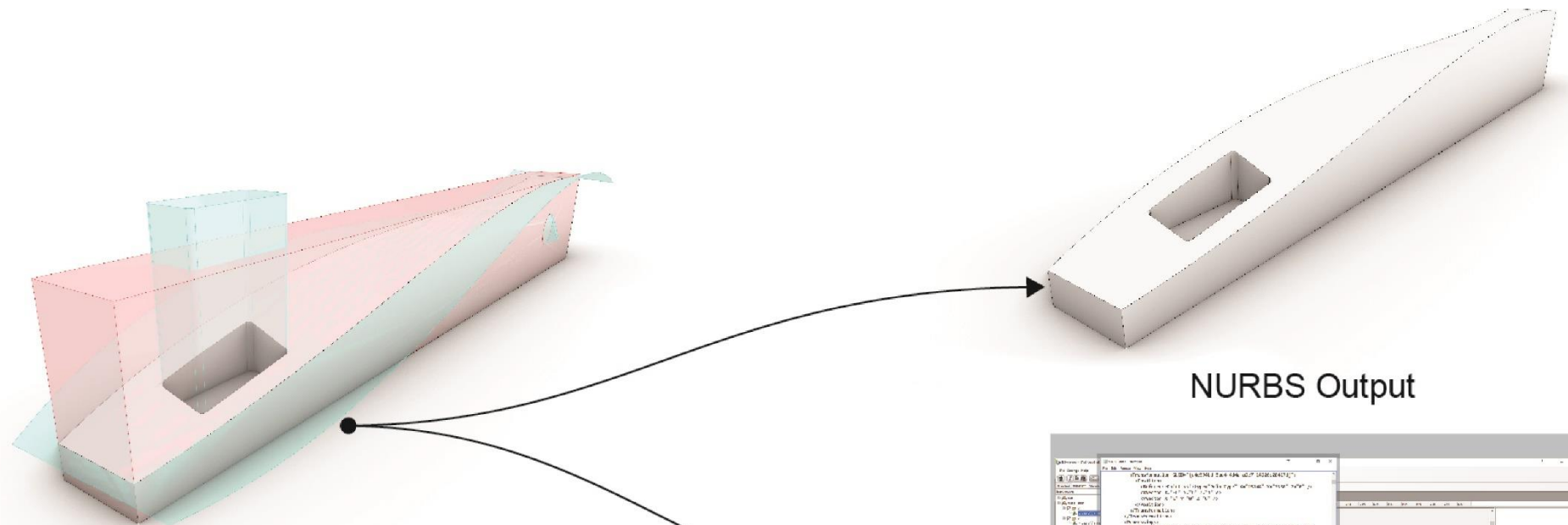

Subtractive Operations

NURBS Output

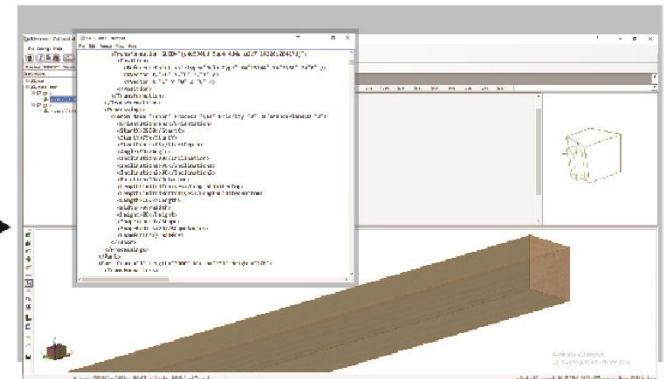

BTLx xml-file

ArkitektModell ProdusentModell

konstruksjonssystemet: Innslissa DybelPlater

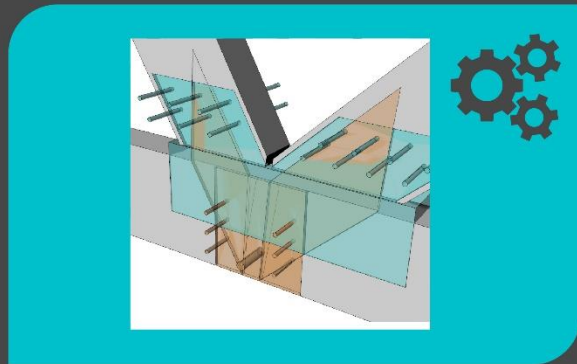

Konstruksjon-
System

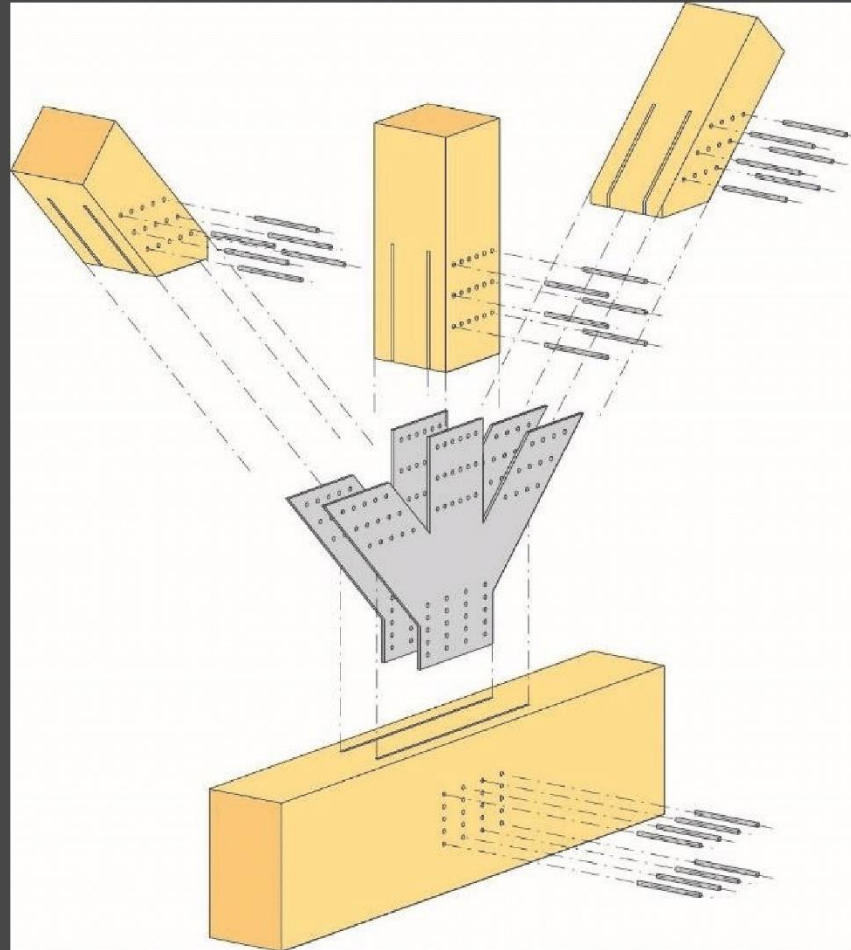

konstruksjonssystemet: Innslissa DybelPlater

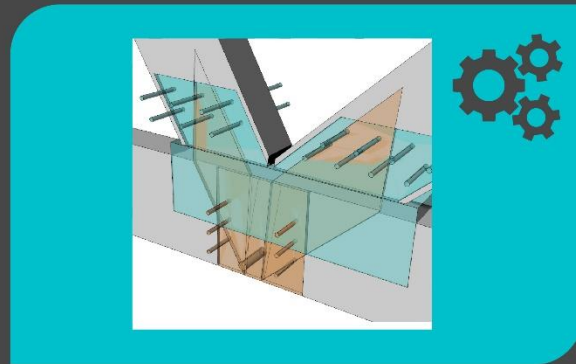

Konstruksjon-
System



Follo Bru



Evjen Bru



Sølvpilen



Vasshoppet

Perspective ▾



RECORDED WITH

SCREENCAST O MATIC

Perspective Top Front Right ↻

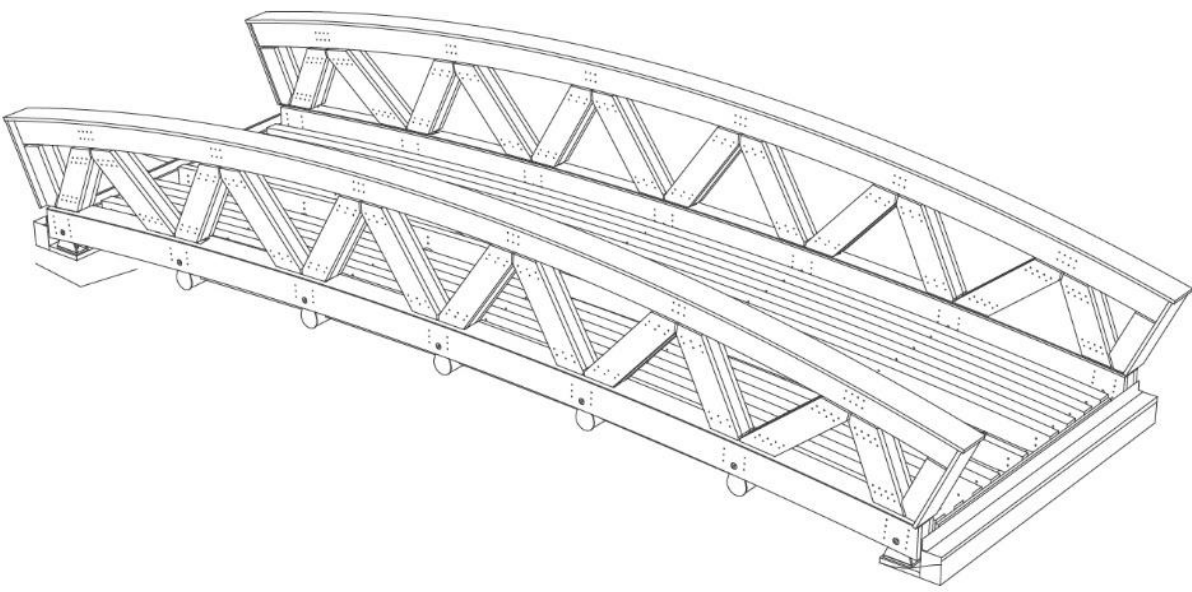
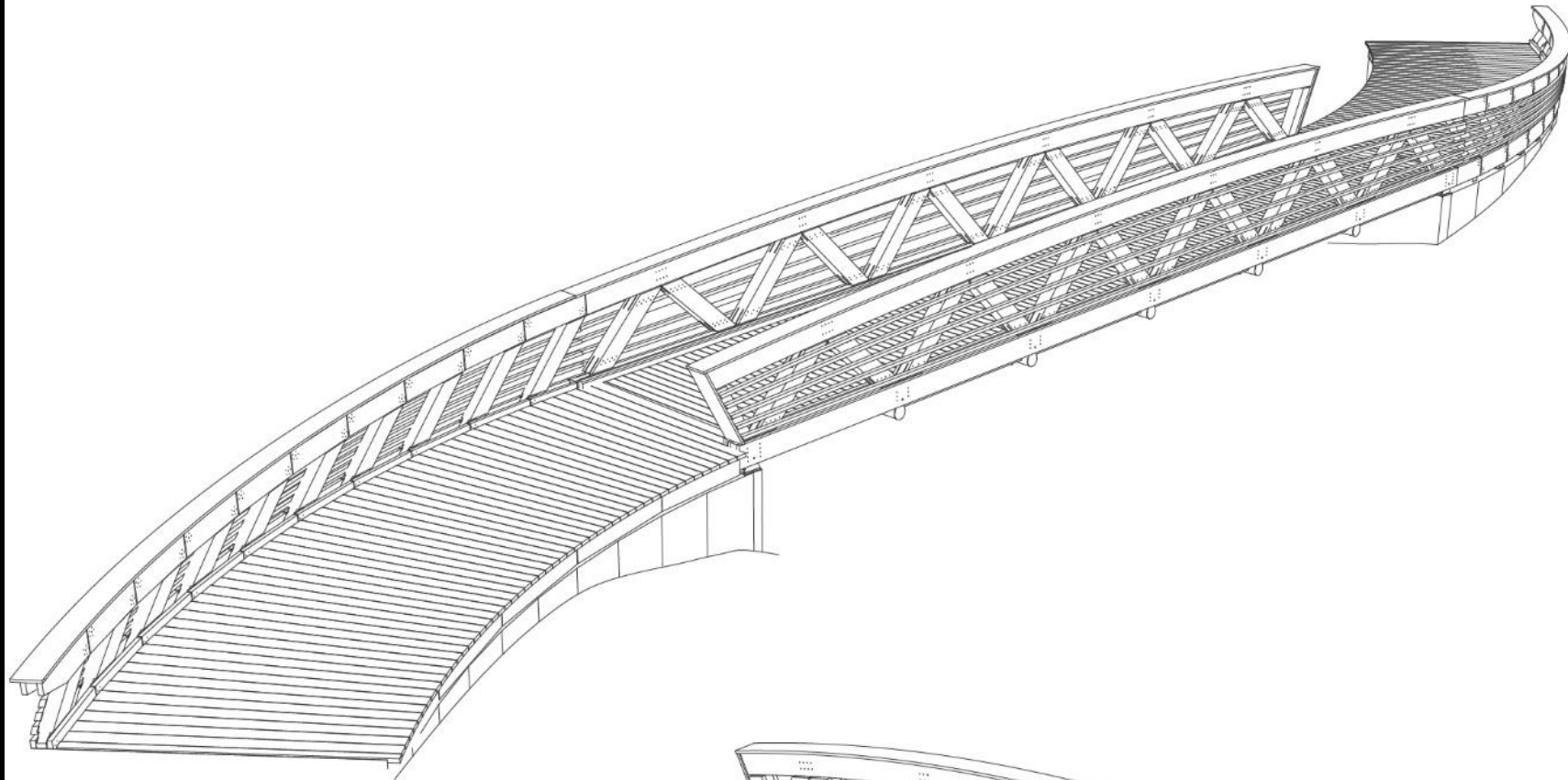

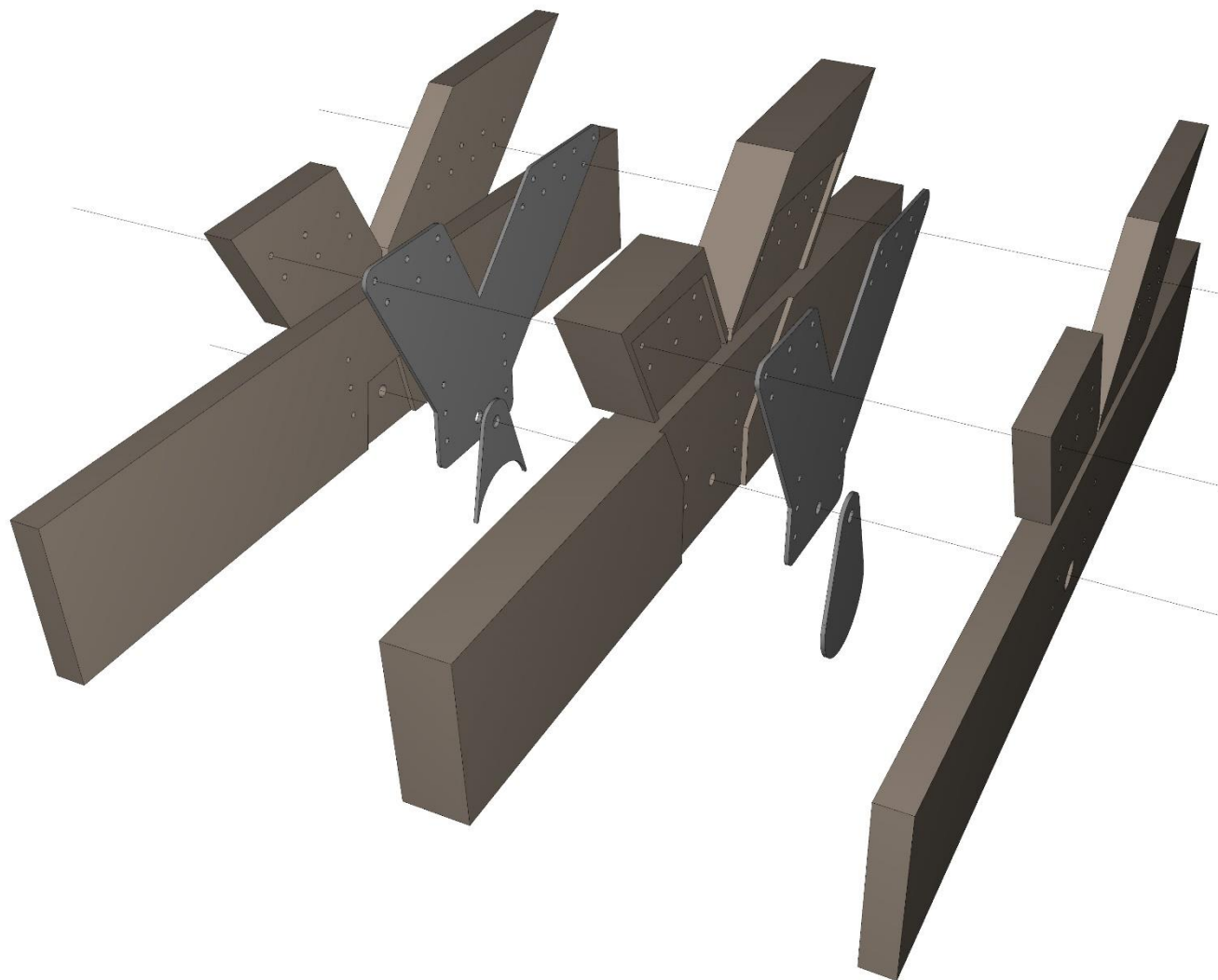
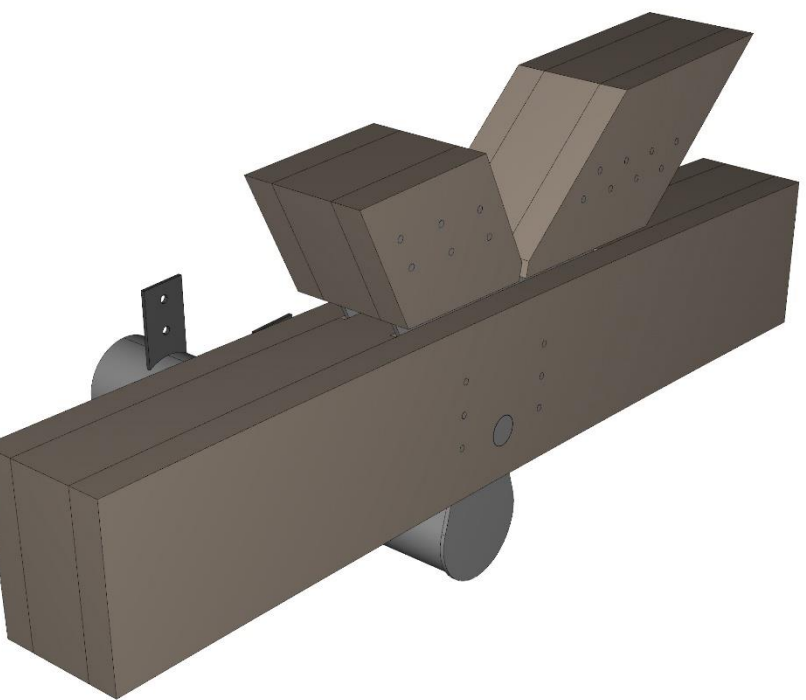









Arnfinn Søthre

Follo Bru



Follo Bru



Infinn Løthre

Evjen Bru



Arnfinn Fæthre

Evjen Bru







Parametrisk Hylle



Front

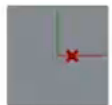

50 cm

RECORDED WITH
SCREENCAST  MATIC

Perspective

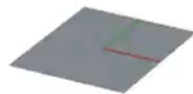

x

+

z
y
x



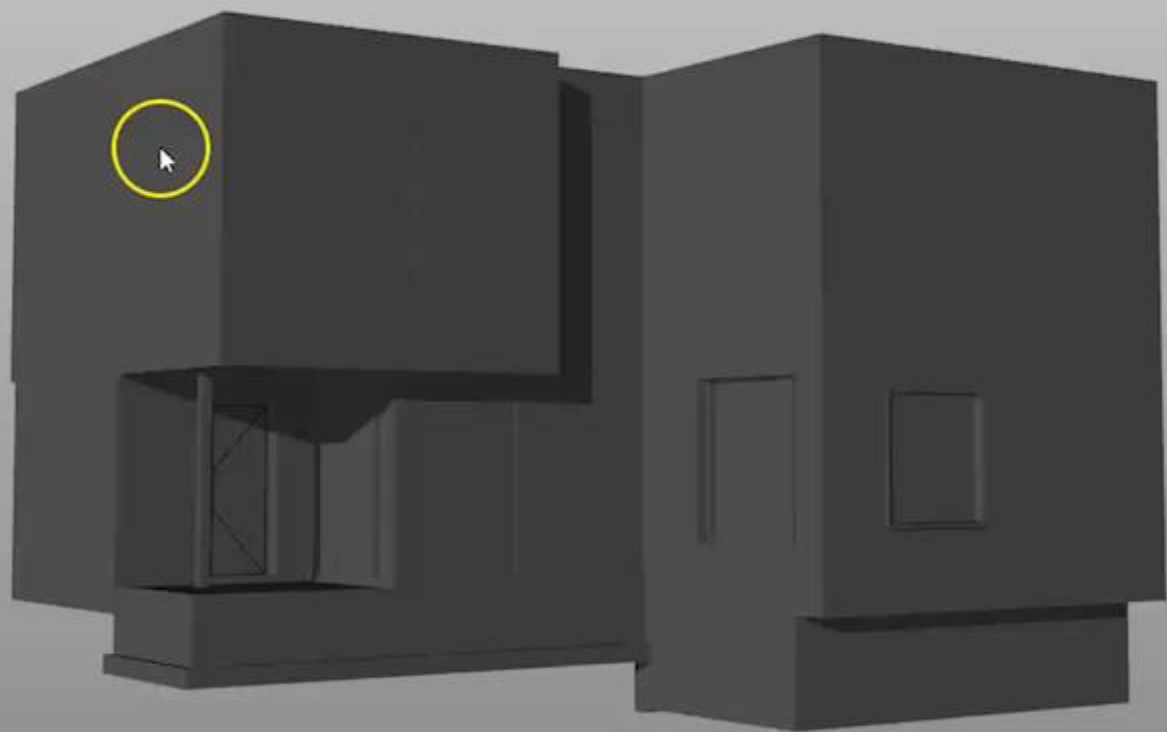











ments

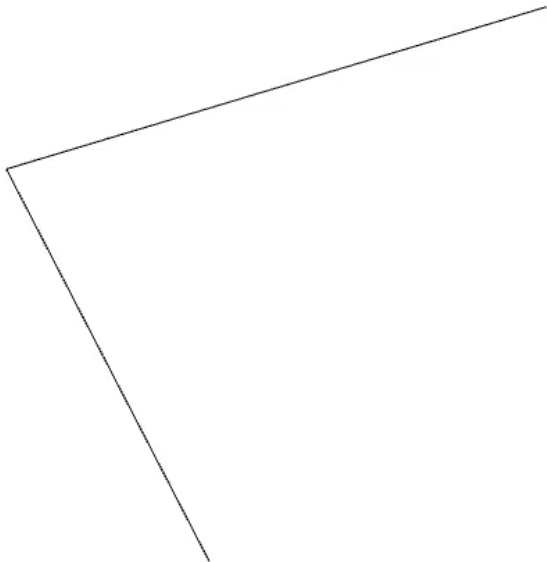

z
y

TotalHøgde 1000

VaskeHøgde 70

AvstandFråLektEnde 60

TjukkelseVange 24

AntalSpilerPrModul 10

B

{0}
0 Lengde 930
1 Navn B
2 Antal Spiler 1
3 TotalLengde 930

Frå å designe konstruksjon**en**
til å designe konstruksjon**systemet**